

Programmable AC Power Source

Key Features:

- Power rating
 - 61509/61609: 6kVA
 - 61508/61608: 4.5kVA
 - 61507/61607: 3kVA
- Voltage range: 0-175V/0-350V/Auto
- Frequency: DC, 15Hz-2kHz
- Single-phase or three-phase output selectable
- Programmable slew rate setting for changing voltage and frequency
- Programmable voltage and current limit
- High output current crest factor inrush current testing
- Turn on and turn off phase angle control
- TTL signal which indicates output transient
- LIST, PULSE, STEP mode functions for testing Power Line Disturbance (PLD) simulation
- Voltage dips, short interruption, and voltage variation simulation
- Harmonics and inter-harmonics waveform synthesizer
- Comprehensive measurement capability including current harmonics
- Analog programmable interfaces
- Remote interface: GPIB, RS-232, USB, and Ethernet
- Capable of delivering higher output power by implementing master-slave parallel output function



Programmable AC Power Source Model 61509/61508/61507/61609/61608/61607

The global market for AC power testing demands for a more sophisticated, high performance AC power source capable of simulating a wide range of AC line conditions. The 61509/61508/61507/61609/61608/61607 models are the latest of the 61500/61600 series AC source based on high power density and low form factor (5U) design. The Chroma 61500/61600 series programmable AC source are the right solutions needed to meet the market's requirements due to its ability to simulate various AC line input conditions and measure critical product characteristics under testing. These features make the 61500/61600 series ideal for commercial, power electronics, avionics, military, and regulation test applications from bench-top R/D design verification and quality assurance to mass production. The enhancement of DC functionality with DC power ratings of up to 75% of full output power has further extended test application capabilities especially for AC/DC server PSU.

Using state of the art PWM technology, the 61509/61508/61507/61609/61608/61607 models can deliver the maximum output voltage of up to 350Vac and output frequency of 15Hz to 2000Hz. All models possess the ability to generate pure sine waveform output with typical distortion of less than 0.3% at 50/60Hz.

The Chroma 61500/61600 series are able to provide precision measurements such as RMS voltage, RMS current, true power, power factor, current crest factor, and so on. By applying the advanced DSP technology, the 61509/61508/61507 models can easily simulate power line disturbance (PLD) by LIST, PULSE, and STEP modes.

The Chroma 61500/61600 series allow users to compose different harmonic components to synthesize various harmonic and distorted waveforms. By applying this advanced feature, users can program a sweeping frequency component incorporated with the fundamental voltage for finding the resonance points of the UUT, thus providing the user with an in depth analytical result.

To simulate the natural waveform, the Chroma 61500/61600 series provide an external analog input to amplify the analog signal generated by the arbitrary signal generator. Thus, the user can implement this feature to duplicate unique waveforms observed in the field. The friendly interface allows for quick user access to the 61509/61508/61507/61609/61608/61607 AC sources' functions through a large graphic LCD display front panel with an easy to use keypad. The GPIB, RS-232, USB, and Ethernet interfaces are available to control the AC source remotely.



FUNCTIONS AND APPLICATIONS

SINGLE PHASE AND THREE PHASE OUTPUT

Model 61509/61508/61507/61609/61608/61607 AC sources are capable of delivering single or three-phase output depending on the application. Users can select these output modes easily through the front panel or via remote control. All models are able to provide full power output without derating even with the single phase output configuration.

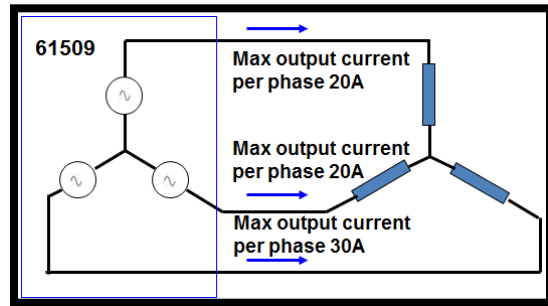
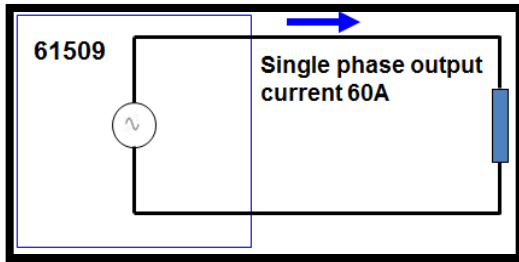

POWER LINE DISTURBANCE SIMULATION (61500 SERIES)

In addition to the ability to program steady output voltage and frequency, Chroma AC power source 61500 series provides powerful functions to simulate all kinds of power line disturbance conditions. The STEP and PULSE modes offer easy and convenient methods to execute single step or continuous output changes. The changes may be triggered by an internal or external event. This allows for an easy simulation of power line disturbances such as cycle dropout, transient spike, brown out, etc. The LIST mode extends this function for more complex waveform generator needs of up to 100 sequences with different start-end conditions that can perform almost any waveform by AC and DC components. The Chroma AC power source 61500 series is also capable of simulating all sorts of voltage dips, interruptions, and variation waveforms for IEC 61000-4-11 pre-compliance tests and IEC61000-4-14/IEC61000-4-28 compliance tests.

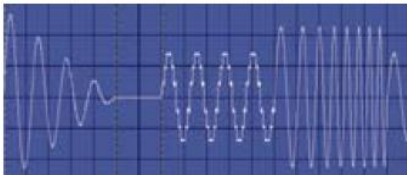

LIST Mode



PULSE Mode

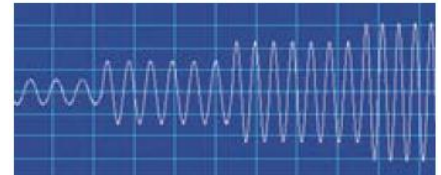

STEP Mode

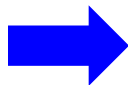

Most importantly the LIST mode is capable of simulating the below voltage waveform test requirements for AC/DC server PSU.

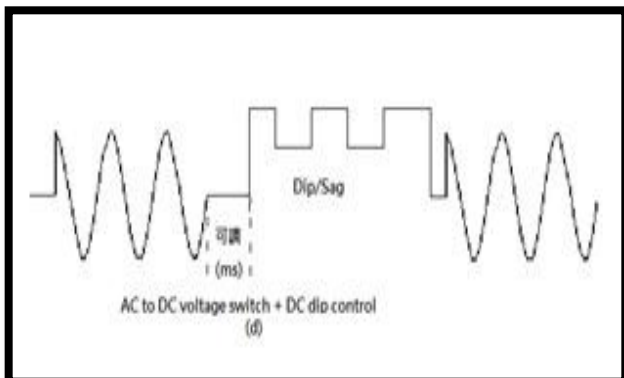

Voltage waveform test requirement

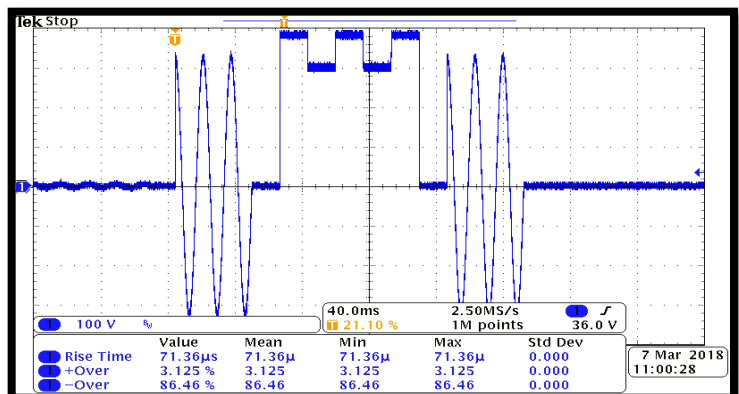

Actual output voltage waveform

FUNCTIONS AND APPLICATIONS

SLEW RATE SETTING FOR VOLTAGE AND FREQUENCY

Model 61509/61508/61507/61609/61608/61607 AC sources let users set the slew rate of voltage and frequency. The program will follow the slew rate used to reach the final setting when the output voltage or frequencies are changed. This function helps users verify the operating range of input power. For example, users can implement this feature to sweep the voltage gradually from 90V to 264V instead of only checking several points like 90V, 115V, 230V, and 264V. Additionally, in order to reduce the inrush current during motor startup or UUT power up, the user can decrease the slew rate setting to achieve the objective.



Output voltage waveform based on voltage of slew rate setting

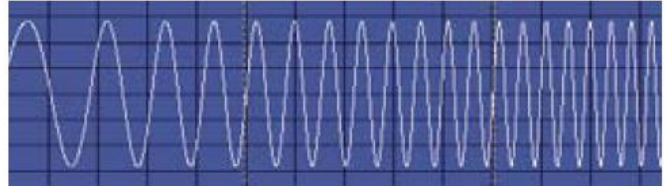

Output voltage waveform based on frequency of slew rate setting

DISTORTION WAVEFORM, HARMONICS, AND INTERHARMONICS (61500 SERIES)

Traditional types of AC sources only provide output voltages with SIN waveforms; these types of AC sources are unable to meet or keep up with the latest test requirements for simulating the input voltage's abnormal conditions with distorted waveforms. The WAVEFORM function allows users to set square, clipped-sine waves and 30 stored distortion waveforms. Besides that, IEC 61000-4-13 standards require not only the harmonics waveform, but also the inter-harmonics simulation. Chroma 61500 series allow users to compose up to 50 orders of harmonics based on 50Hz or 60Hz; the output will be a periodic harmonics distortion waveform. It also provides sweeping inter-harmonics functions. This means the fundamental frequency will be incorporated with a frequency sweeping component between harmonic frequencies. It can help find the resonance or the weakest points of the UUTs. Chroma AC source 61500 series uses advanced DSP technology to synthesize the harmonic and inter-harmonics waveforms. Therefore, it is capable of generating periodic harmonic and non-periodic harmonic distorted waveforms to perform IEC 61000-4-13 compliance tests.

1_Phase SYNTHESIS QUIT									
SYNTHESIS WAVEFORM FUNDAMENTAL SETTING									
Vac fundamental = 0.0V					Vdc = 0.0V				
F fundamental = 60Hz					Degree = 0.0°				
N	V	θ	N	V	θ	N	V	θ	
2	0.00	0.0	19	0.00	0.0	36	0.00	0.0	
3	0.00	0.0	20	0.00	0.0	37	0.00	0.0	
4	0.00	0.0	21	0.00	0.0	38	0.00	0.0	
5	0.00	0.0	22	0.00	0.0	39	0.00	0.0	
6	0.00	0.0	23	0.00	0.0	40	0.00	0.0	
7	0.00	0.0	24	0.00	0.0	41	0.00	0.0	
8	0.00	0.0	25	0.00	0.0	42	0.00	0.0	
9	0.00	0.0	26	0.00	0.0	43	0.00	0.0	
10	0.00	0.0	27	0.00	0.0	44	0.00	0.0	
11	0.00	0.0	28	0.00	0.0	45	0.00	0.0	
12	0.00	0.0	29	0.00	0.0	46	0.00	0.0	
13	0.00	0.0	30	0.00	0.0	47	0.00	0.0	
14	0.00	0.0	31	0.00	0.0	48	0.00	0.0	
15	0.00	0.0	32	0.00	0.0	49	0.00	0.0	
16	0.00	0.0	33	0.00	0.0	50	0.00	0.0	
17	0.00	0.0	34	0.00	0.0				
18	0.00	0.0	35	0.00	0.0				

List Mode	Pulse Mode	Step Mode	Synthesis	Inter-harmonics	Harmonic Meas.	2017/11/30 20:24:34
-----------	------------	-----------	-----------	-----------------	----------------	------------------------

1_Phase SYNTHESIS QUIT						
SYNTHESIS WAVEFORM VIEWER						
List Mode	Pulse Mode	Step Mode	Synthesis	Inter-harmonics	Harmonic Meas.	2017/11/30 20:29:18

FUNCTIONS AND APPLICATIONS

COMPREHENSIVE MEASUREMENTS

Chroma AC Power Source 61500/61600 series have built-in 16-bit measurement circuits and firmware utilities to measure the true RMS voltage, current, true power, apparent power, reactive power, power factor, current crest factor, repetitive peak current, and inrush current. Using advanced DSP technology, the 61500 series can measure THD and up to 50 orders of current harmonics.

AC SOURCE PARALLEL OUTPUT FUNCTION

The 61509/61508/61507/61609/61608/61607 AC source models provide (Master-Slave) parallel output functions, which enable users to extend the AC source power output ability by connecting AC sources in parallel.

Connect Master/Slave units



SOFTPANEL

Chroma's Softpanel is a graphical user interface that provides extraordinary capabilities and convenience to users by delivering control to the unit. The 61500/61600 series Softpanel is designed specifically to offer the user control of the AC source by applying user friendly interfaces configured in graphical and instrument like settings. The self-explanatory graphical interface makes enabling extensive functions of the AC source possible with just few clicks.

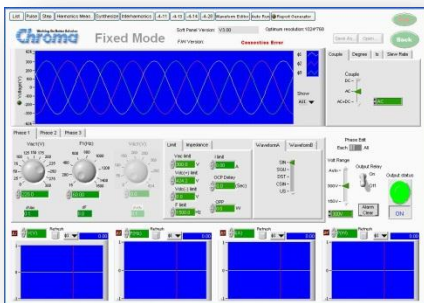

Main Operation Menu

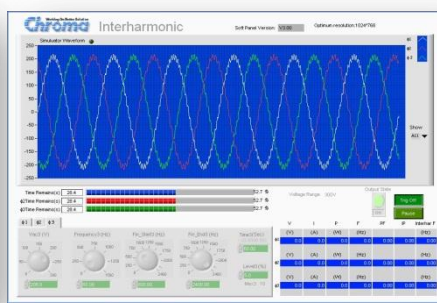

Interharmonic Test



Transient Voltage Programming

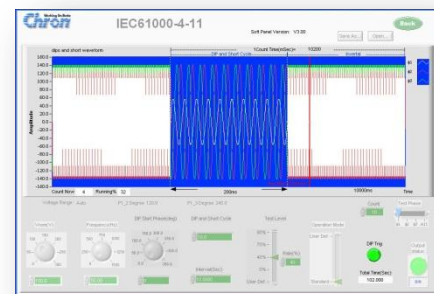

Voltage DIP, Short Interruption, Variation Regulation Test



Distorted Waveform Editor



Recording Function

PANEL DESCRIPTION

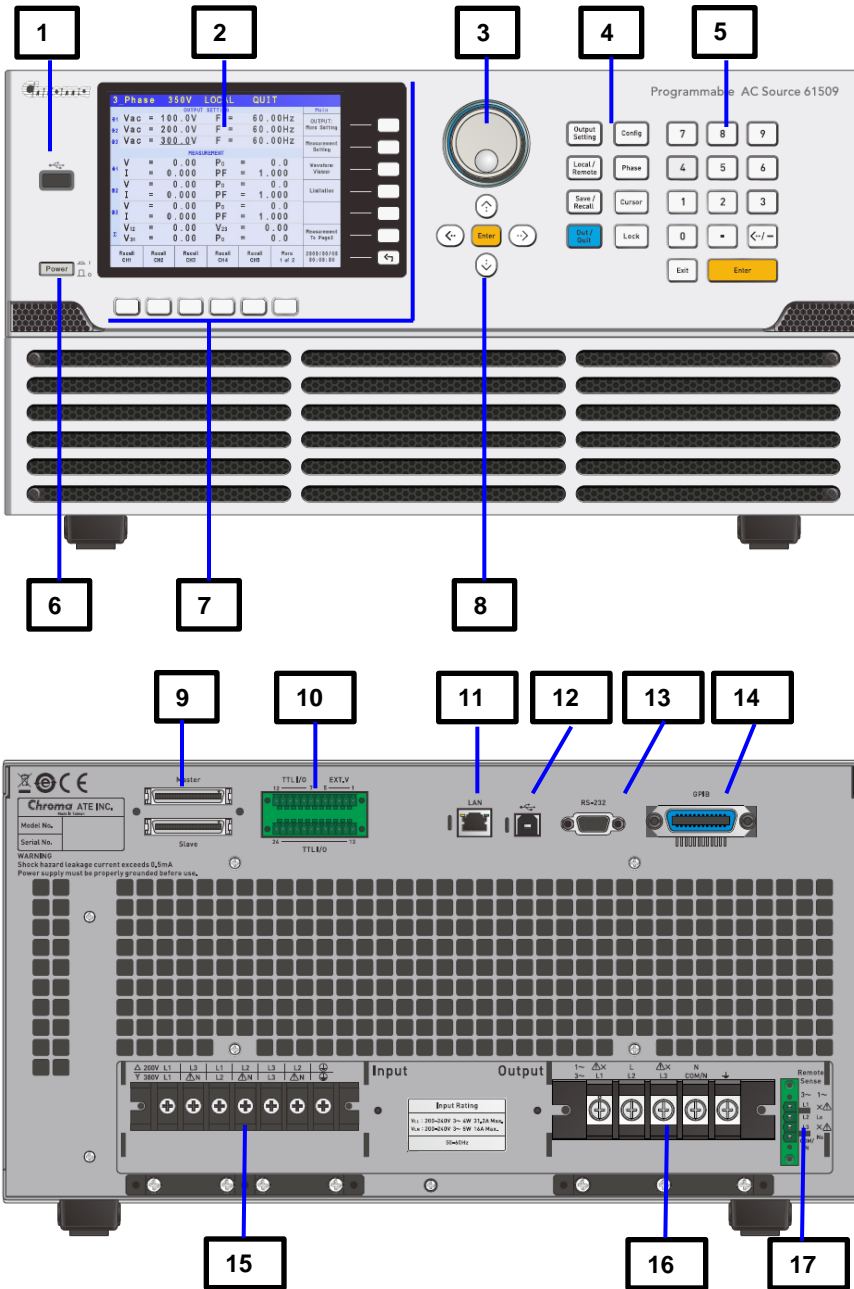

1. USB Host

2. LCD Display

5.7 inch graphic LCD display for settings and measurements read back

3. Rotary Knob

For adjusting voltage, frequency, and other parameter settings

4. Function key

Hot keys for quick parameter settings

5. Numeric key

For data setting

6. ON/OFF Power Switch

7. Soft key

Supports menu driven interface

8. Cursor key

For cursor movement

9. Master/Slave Port

For parallel application

10. External V reference/TTL I/O Port

External analog signal for voltage control and signal for system integration

11. Ethernet Interface

12. USB Interface

13. RS232 Interface

14. GPIB Interface

15. Input Terminal

16. Output Terminal

17. Remote Sense

For output voltage compensation

ORDERING INFORMATION

- 61507***: Programmable AC Source 0~350V, 15~2kHz / 3kVA
- 61508***: Programmable AC Source 0~350V, 15~2kHz / 4.5kVA
- 61509***: Programmable AC Source 0~350V, 15~2kHz / 6kVA
- 61607***: Programmable AC Source 0~350V, 15~2kHz / 3kVA
- 61608***: Programmable AC Source 0~350V, 15~2kHz / 4.5kVA
- 61609***: Programmable AC Source 0~350V, 15~2kHz / 6kVA
- A615007** : Softpanel for Model 61500 Series

*Call for availability

SPECIFICATIONS

Model	61507	61607	61508	61608	61509	61609
AC Output Rating						
Output Phase	1 or 3 selectable					
Max. power	3kVA		4.5kVA		6kVA	
Per Phase	1kVA		1.5kVA		2kVA	
Voltage						
Range	0~175V/0~350V/Auto					
Setting Accuracy	0.1% of RD + 0.2% of FS Above 1 kHz, add 0.2%/kHz to FS					
Resolution	0.1 V					
Distortion	< 0.3% @50/60Hz < 1% @15Hz ~ 500Hz 1% maximum to 500Hz, add 0.5%/kHz up to 2kHz					
Line regulation	0.10%					
Load regulation	0.20%					
Maximum current (1-Phase Mode)						
RMS	30A/15A		45A/22.5A		60A/30A	
Peak (CF=4)	120A/60A		360A/180A		240A/120A	
Maximum current (each phase in 3-Phase Mode)						
RMS	10A/5A		15A/7.5A		20A/10A	
Peak (CF=4)	40A/20A		60A/30A		80A/40A	
Frequency						
Range	15Hz ~ 2000Hz					
Accuracy	0.01%					
DC Output (1-Phase Mode)						
Power	75% of Full Load		75% of Full Load		75% of Full Load	
Voltage	247.5V/495V		247.5V/495V		247.5V/495V	
Current	22.5A/11.25A		33.75A/16.875A		45A/22.5A	
DC Output (3-Phase Mode)						
Power	75% of Full Load		75% of Full Load		75% of Full Load	
Voltage	247.5V/495V		247.5V/495V		247.5V/495V	
Current	7.5A/3.75A		11.25A/5.625A		15A/7.5A	
Input Rating						
Voltage operating range	3Ø 200-240V±10%VLN (WYE) 3Ø 200-240V±10%VLL (Delta)					
Current	11.5A Max./Phase (3Ø 200-240V±10%VLL)		17.3A Max./Phase (3Ø 200-240V±10%VLL)		23A Max./Phase (3Ø 200-240V±10%VLL)	
Power factor	0.97 (Typical)					
Measurement						
Voltage						
Range	0~175V/0~350V/Auto					
Accuracy	0.1% of RD+0.2% of FS					
Current						
Accuracy (RMS)	0.2% of RD+0.2% of FS					
Accuracy (peak)	0.2% of RD+0.4% of FS					
Power						
Accuracy	0.2% of RD+0.4% of F.S.					
Others						
Efficiency	>80%(Typical)					
Protection	OVP,OCP,OPP,OTP,FAN					
Safety & EMC	CE mark					
Dimension (HxWxD)	221.5 x 425 x 680mm / 8.72 x 16.73 x 26.77inch					
Weight	55kg / 121lbs					